

ABB-Welcome Midi
Vizualizace venkovní stanice

1x

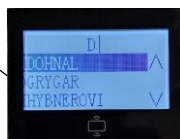

Výběr účastníků v jmenném abecedně seřazeném rolovacím 3-řádkovém menu nebo též přímou volbou „adresou“ účastníka.

Jednoduchá správa čipů přes admin čip:



Videoukázka zde:

<https://new.abb.com/low-voltage/cs/nizke-napeti/produkty/automatizace-bytu-a-budov/produktove-rady/domovni%C3%AD-telefony/pristupove-cipy>



Rozměry krytů a otvorů pro instalační krabice:

https://nizke-napeti.cz.abb.com/files/repository/V-kryty_krabice_strisky_moduly_Welcome_Midi_platform_135_v1.3.pdf

ABB-Welcome Midi
Možné kombinace vnitřních stanic

60x

nebo



nebo

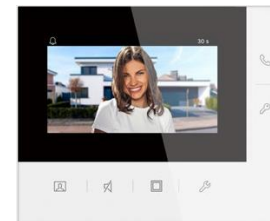
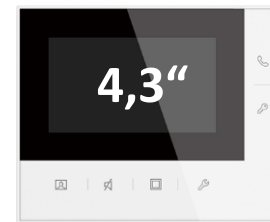

nebo

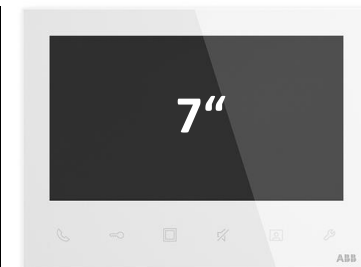

Editace jmenovek bez nutnosti demontáže krytu – šablona v excelu zde:

<https://nizke-napeti.cz.abb.com/otazky-a-odpovedi-jak-editovat-a-tisknout-jmenovy-k-19394?q=otazky-a-odpovedi-jak-editovat-a-tisknout-jmenovy-k-19394>

ABB-Welcome Midi

Ovládání vchodových dveří audiotelefonem resp. videotelefonem



Odemknutí vchodu

Příjem hovoru

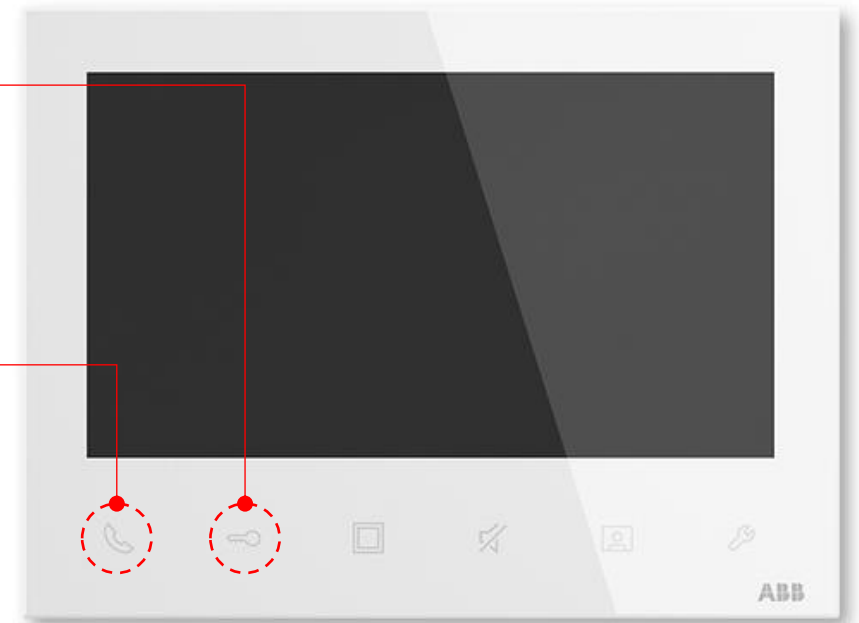

8.NP

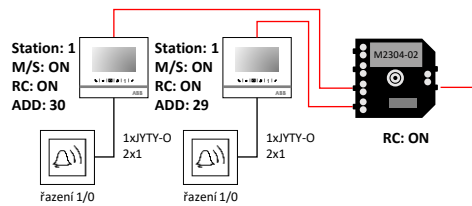

8.NP

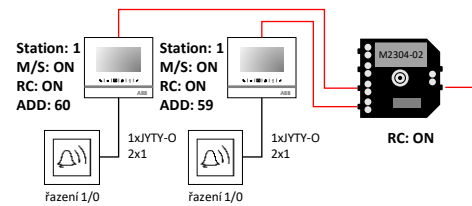

7.NP

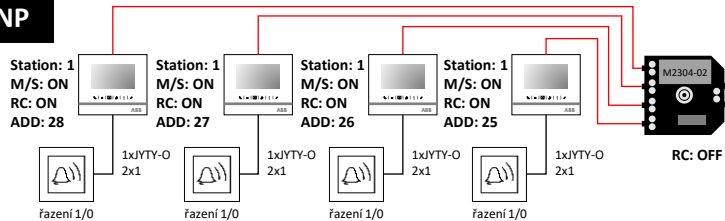

7.NP

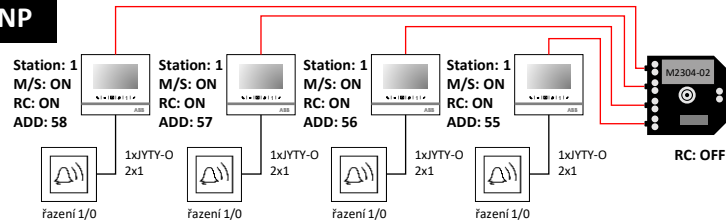

6.NP

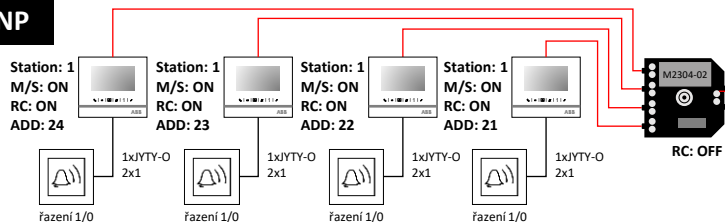

6.NP

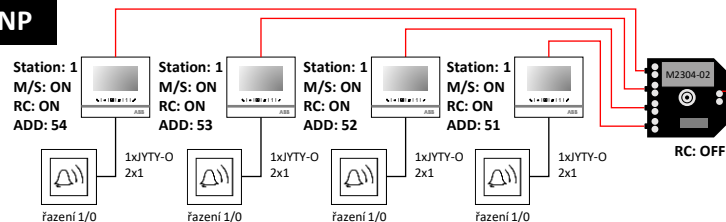

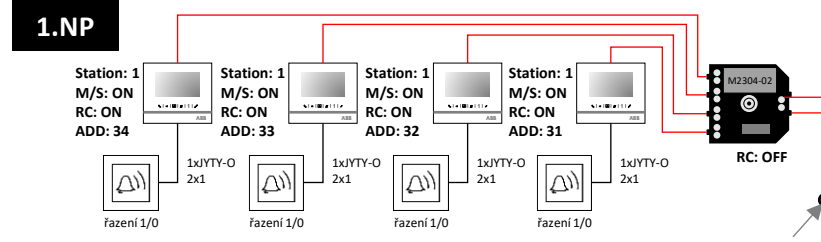
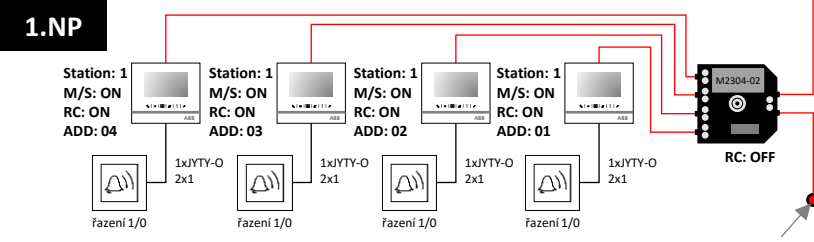
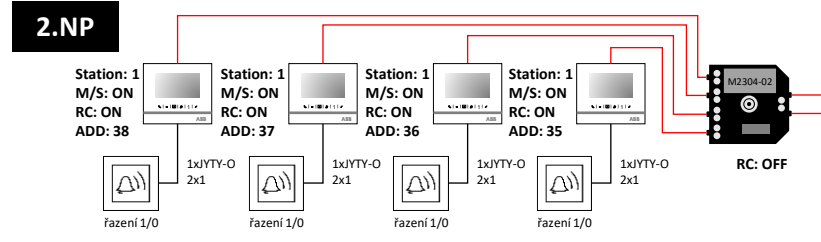
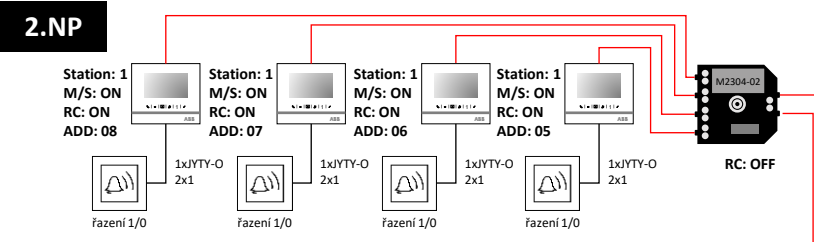
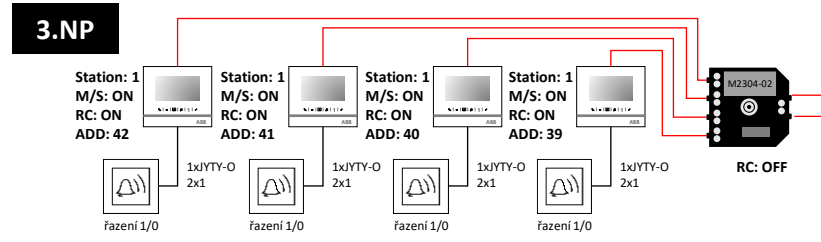
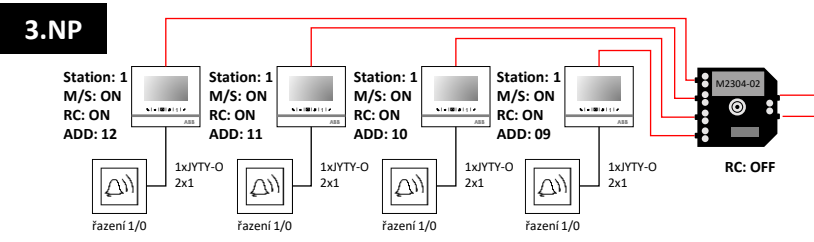
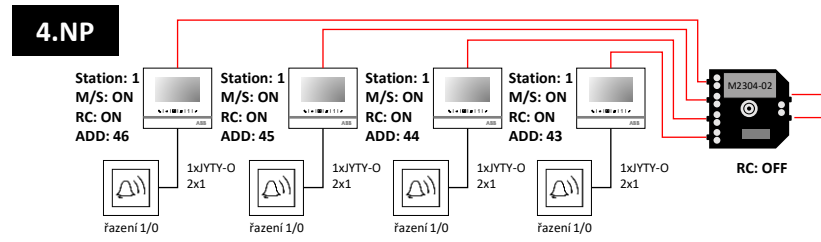
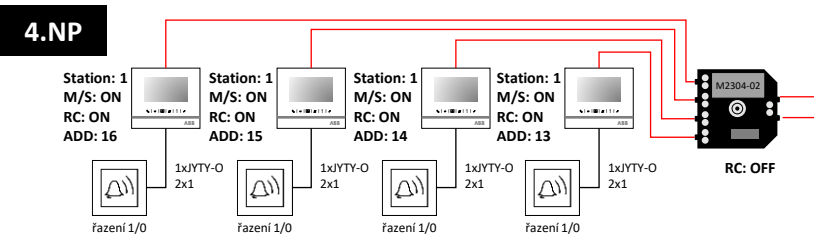
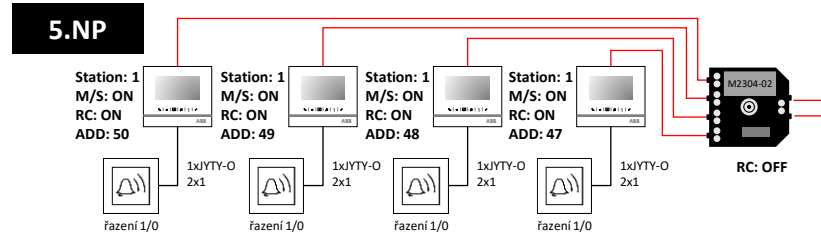
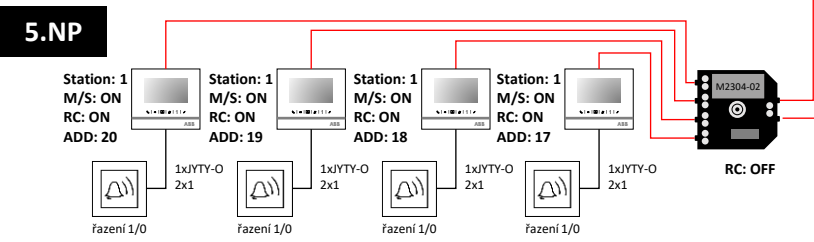

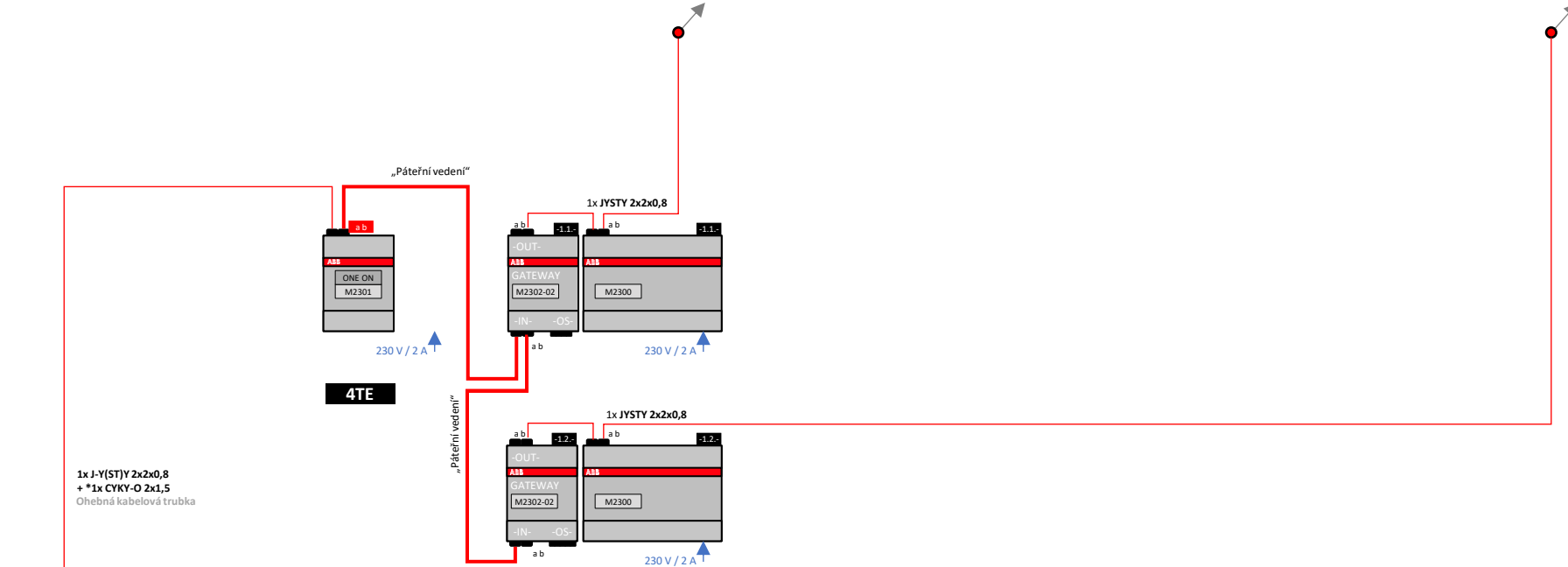

1x J-Y(STY) 2x2x0,8
+ *1x CYKY-O 2x1,5
Ohebná kabelová trubka



-1.1-
Gateway mode: Additional power supply mode
Gateway mode: Pomocné napájení
1-OFF; 2-ON; 3-ON
4-RC: OFF
ADD: 00

-1.2-
Gateway mode: Additional power supply mode
Gateway mode: Pomocné napájení
1-OFF; 2-ON; 3-ON
4-RC: ON
ADD: 00

Σ délky kabelů = 1 řídicí jednotka M2300-02
max. 800 m

Max. vzdálenost od řídicí jednotky M2300-02 k nejbližší vnitřní stanici = **max. 100 m**

Nastavení venkovního tabla (Station 1) – nastavení na hlasovém modulu



ABB-Welcome Midi



Až 18 V AC/DC, 250 mA
 Doporučený zámeček:
 12 V DC, nízkoodběrový (max. 250 mA)

Nastavení venkovního tabla (Station 1) – nastavení na hlasovém modulu

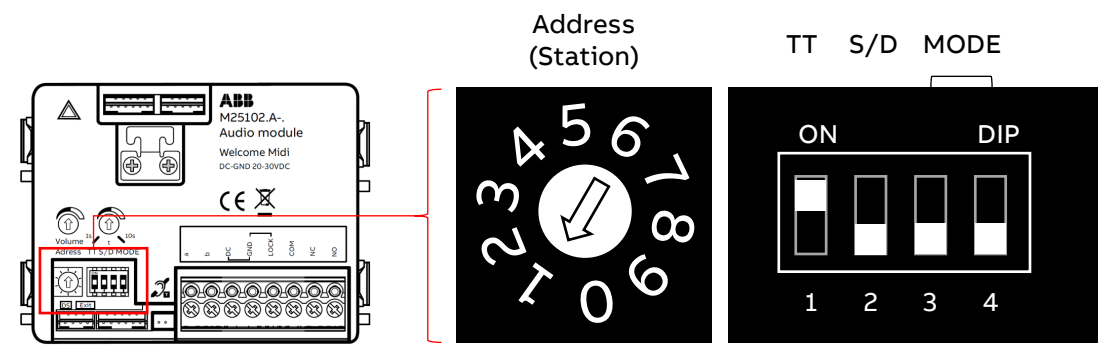
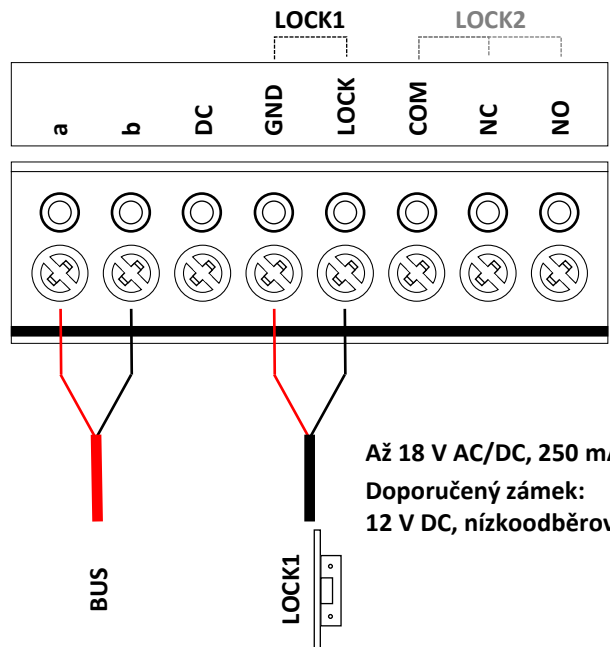
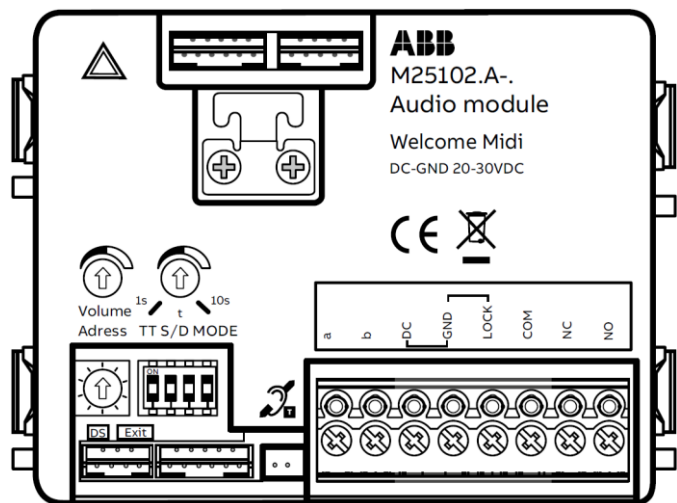
Address
(Station)

TT S/D MODE



ABB-Welcome Midi
Hlasový modul – klasické zapojení



Nastavení venkovního tabla (Station 1) – nastavení na hlasovém modulu

Address
(Station)

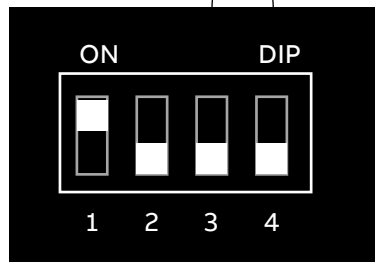
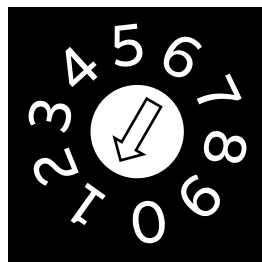
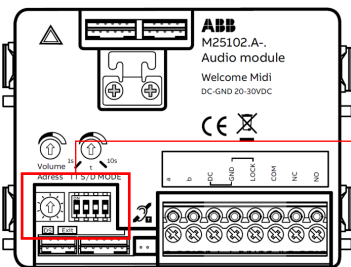
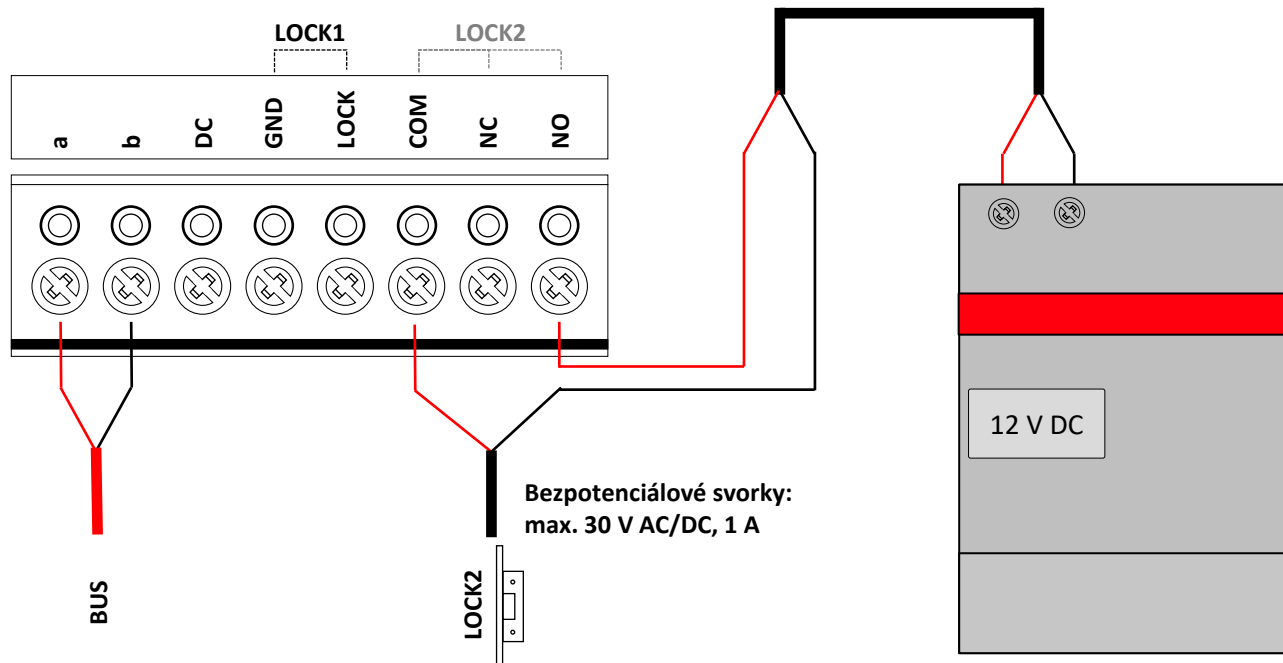
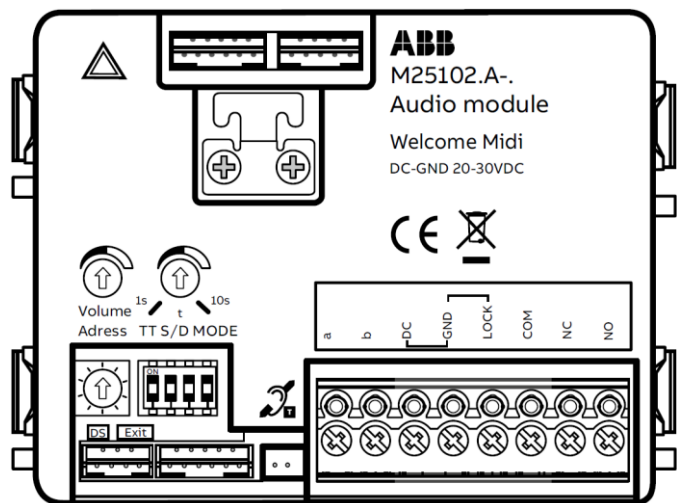
TT S/D MODE



ABB-Welcome Midi
Hlasový modul – zapojení s externím napájením LOCK2



Např. adresa „24“:

Station: 1
M/S: ON
RC: ON
ADD: 24

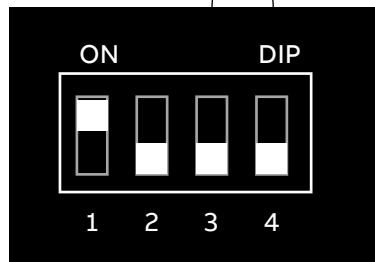
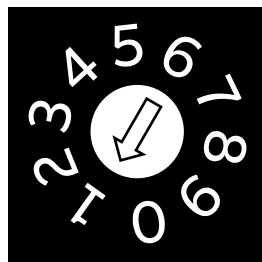
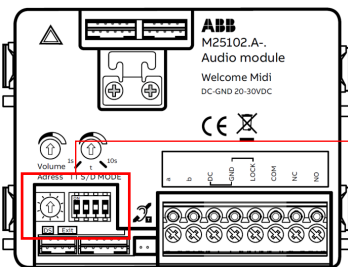
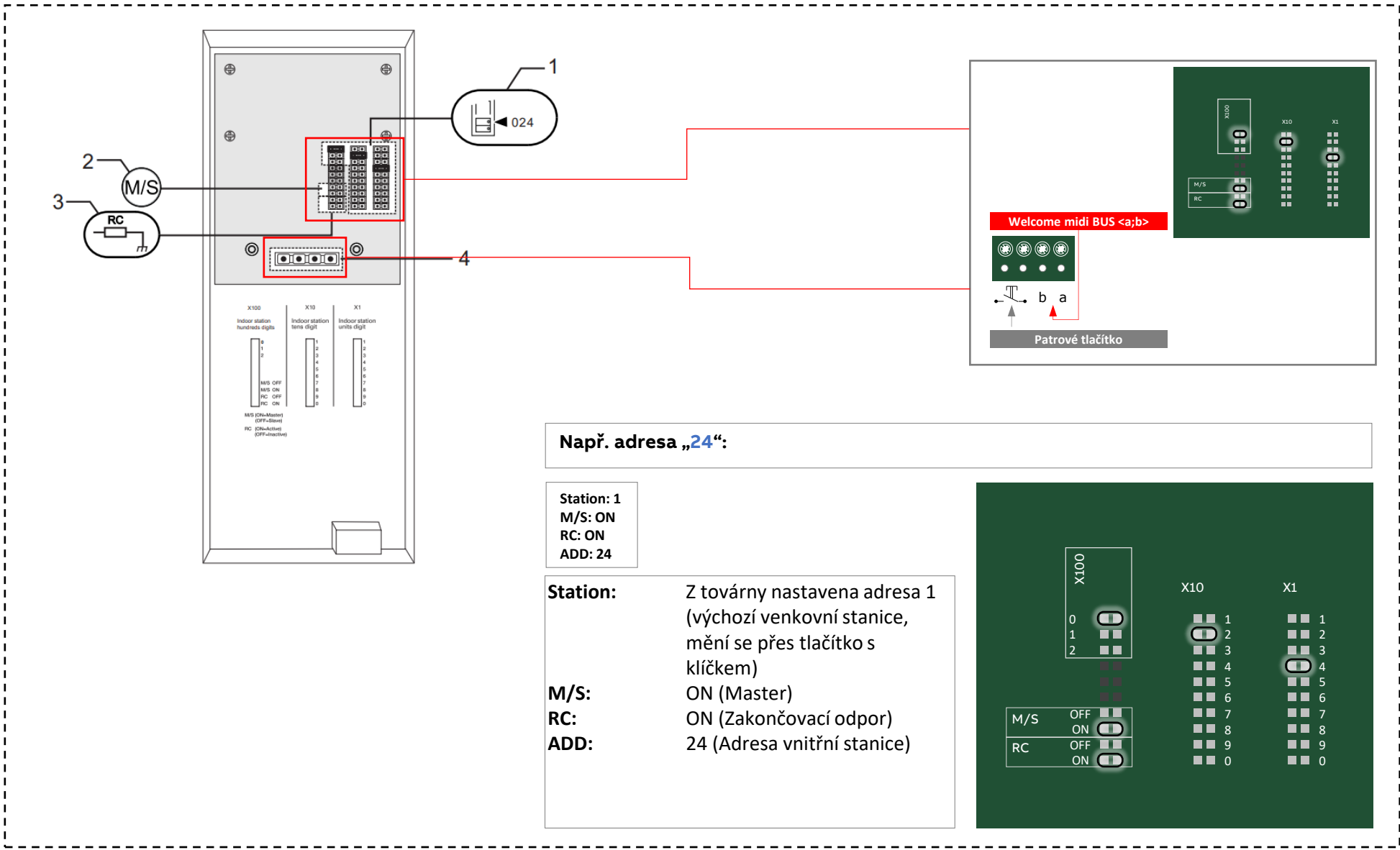
Station: Z továrny nastavena adresa 1 (výchozí venkovní stanice, mění se přes tlačítko s klíčkem)
M/S: ON (Master)
RC: ON (Zakončovací odpor)
ADD: 24 (Adresa vnitřní stanice)

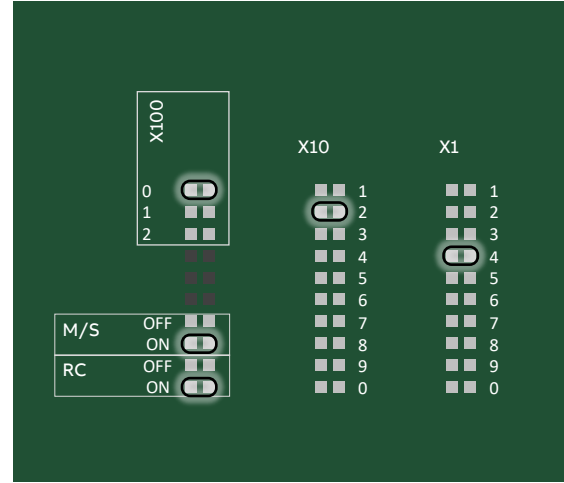

CZ návod (karta dokumenty):
<https://nizke-napeti.cz.abb.com/telefon-domovni-se-sluchatkem-17910/telefon-domovni-se-sluchatkem-2tma210050w0001>

ABB-Welcome Midi
Sluchátkový telefon – nastavení adresy

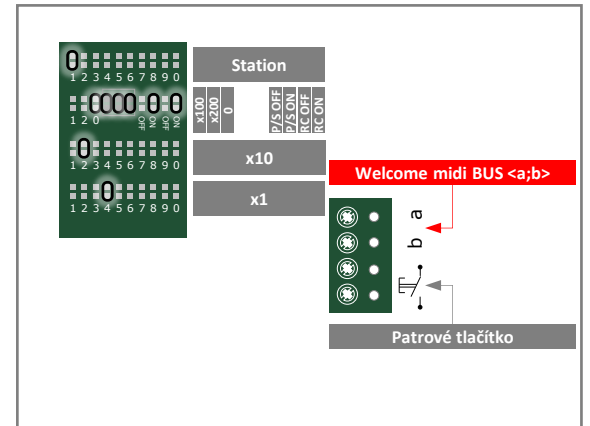
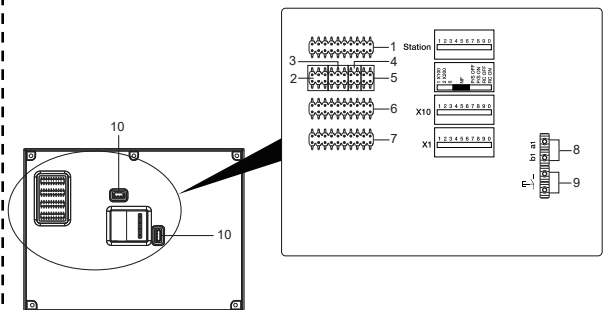

Např. adresa „24“:

Station: 1
M/S: ON
RC: ON
ADD: 24

Station: Z továrny nastavena adresa 1 (výchozí venkovní stanice).
M/S (P/S): ON (Master neboli Primary)
RC: ON (Zakončovací odpor)
ADD: 24 (Adresa vnitřní stanice)

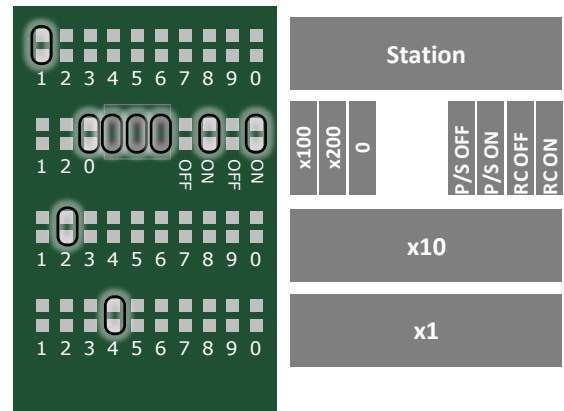

MASTER = „Primary“; SLAVE = „Secondary“

CZ návod (karta dokumenty):
<https://nizke-napeti.cz.abb.com/videtelefon-s-hands-free-ovladanim-7-19551/videtelefon-s-hands-free-ovladanim-7-2tma210051w0001#>

**ABB-Welcome Midi
7" videotelefon – nastavení adresy**